

**Handbook  
of  
Electrochemical Impedance Spectroscopy**

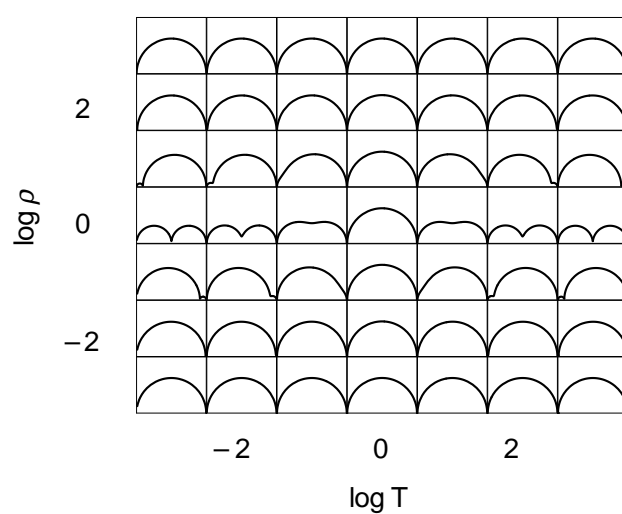

**CIRCUITS  
made of  
RESISTORS and CAPACITORS**

ER@SE/LEPMI  
J.-P. Diard, B. Le Gorrec, C. Montella

Hosted by Bio-Logic @ [www.bio-logic.info](http://www.bio-logic.info)



May 13, 2011



# Contents

<b>1</b>	<b>Circuits made of one R and one C</b>	<b>5</b>
1.1	Circuit $(R+C)$ . . . . .	5
1.1.1	Impedance . . . . .	5
1.1.2	Reduced impedance . . . . .	5
1.2	Circuit $(R/C)$ . . . . .	5
1.2.1	Impedance . . . . .	6
1.2.2	Reduced impedance . . . . .	6
<b>2</b>	<b>Circuits made of two Rs and one C</b>	<b>7</b>
2.1	Circuit $(R_2+(R_1/C_1))$ . . . . .	7
2.1.1	Impedance . . . . .	7
2.1.2	Reduced impedance . . . . .	7
2.2	Circuit $((R_1+C_1)/R_2)$ . . . . .	8
2.2.1	Impedance . . . . .	8
2.2.2	Reduced impedance . . . . .	8
2.3	Transformation formulae between $(R+(R/C))$ and $((R+C)/R)$ circuits . . . . .	8
2.3.1	Transformation formulae $(R+(R/C)) \rightarrow ((R+C)/R)$ . . .	8
2.3.2	Transformation formulae $((R+C)/R) \rightarrow (R+(R/C))$ . . .	9
<b>3</b>	<b>Circuits made of one R and two Cs</b>	<b>11</b>
3.1	Circuit $((R_1/C_1)+C_2)$ . . . . .	11
3.1.1	Impedance . . . . .	11
3.1.2	Reduced impedance . . . . .	11
3.2	Circuit $((R_1+C_2)/C_1)$ . . . . .	12
3.2.1	Impedance . . . . .	12
3.2.2	Reduced impedance . . . . .	13
3.3	Transformation formulae between $((R/C)/C)$ and $((R+C)/C)$ circuits . . . . .	13
3.3.1	Transformation formulae $((R/C)/C) \rightarrow ((R+C)/C)$ . . .	13
3.3.2	Transformation formulae $((R+C)/C) \rightarrow ((R/C)/C)$ . . .	14
<b>4</b>	<b>Circuits made of two Rs and two Cs</b>	<b>15</b>
4.1	Circuit $((R_1/C_1)+(R_2/C_2))$ . . . . .	15
4.1.1	Impedance . . . . .	15
4.1.2	Reduced impedance . . . . .	15
4.2	Circuit $((R_1+(R_2/C_2))/C_1)$ . . . . .	18
4.2.1	Impedance . . . . .	18

4.2.2	Reduced impedance	18
4.3	Circuit $((C_1+(R_2/C_2))/R_1)$	21
4.3.1	Impedance	21
4.3.2	Reduced impedance	21
4.4	Circuit $((C_2+R_2)/R_1)/C_1)$	23
4.4.1	Impedance	23
4.4.2	Reduced impedance	23
4.5	Transformation formulae for RRCC circuits	25
4.5.1	Transformation formulae circuit 2 $\rightarrow$ circuit 1	25
4.5.2	Transformation formulae circuit 1 $\rightarrow$ circuit 2	26
4.5.3	Transformation formulae circuit 3 $\rightarrow$ circuit 1	26
4.5.4	Transformation formulae circuit 1 $\rightarrow$ circuit 3	27
4.5.5	Transformation formulae circuit 4 $\rightarrow$ circuit 1	27
4.5.6	Transformation formulae circuit 1 $\rightarrow$ circuit 4	27
4.5.7	Transformation formulae circuit 3 $\rightarrow$ circuit 2	27
4.5.8	Transformation formulae circuit 2 $\rightarrow$ circuit 3	28
4.5.9	Transformation formulae circuit 4 $\rightarrow$ circuit 2	28
4.5.10	Transformation formulae circuit 2 $\rightarrow$ circuit 4	28
4.5.11	Transformation formulae circuit 4 $\rightarrow$ circuit 3	28
4.5.12	Transformation formulae circuit 3 $\rightarrow$ circuit 4	28

# Chapter 1

## Circuits made of one R and one C

### 1.1 Circuit (R+C)

The symbol '+' denotes the serial association of electrical components.

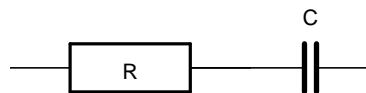

Figure 1.1: Circuit (R+C).

#### 1.1.1 Impedance

$$Z(\omega) = R + \frac{1}{C i \omega} = \frac{R(1 + i \omega \tau)}{i \omega \tau}, \quad \tau = RC$$

$$\operatorname{Re} Z(\omega) = R, \quad \operatorname{Im} Z(\omega) = -\frac{R}{\tau \omega}$$

#### 1.1.2 Reduced impedance

$$Z^*(u) = Z/R = 1 + \frac{1}{i u} = \frac{1 + i u}{i u}, \quad u = \tau \omega, \quad \operatorname{Re} Z^*(u) = 1, \quad \operatorname{Im} Z^*(u) = -\frac{1}{u} \quad (1.1)$$

(Fig. 1.2)

### 1.2 Circuit (R/C)

The symbol '/' denotes the parallel association of electrical components.

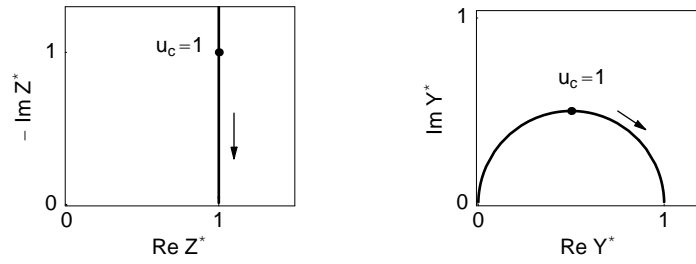

Figure 1.2: Nyquist diagram of the reduced impedance and admittance ( $Y^* = RY$ ) for the (R+C) circuit (Fig. 1.1, Eq. (1.1)). The arrows always indicate the increasing frequency direction.

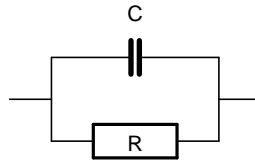

Figure 1.3: Circuit (R/C).

### 1.2.1 Impedance

$$Z(\omega) = \frac{R}{1 + i\omega\tau}, \quad \tau = RC$$

$$\operatorname{Re} Z(\omega) = \frac{R}{1 + \tau^2\omega^2}, \quad \operatorname{Im} Z(\omega) = -\frac{R\tau\omega}{1 + \tau^2\omega^2}$$

### 1.2.2 Reduced impedance

$$Z^*(u) = \frac{Z(u)}{R} = \frac{1}{1 + iu}, \quad u = \tau\omega, \quad \operatorname{Re} Z^*(u) = \frac{1}{1 + u^2}, \quad \operatorname{Im} Z^*(u) = -\frac{u}{1 + u^2} \quad (1.2)$$

(Fig. 1.4)

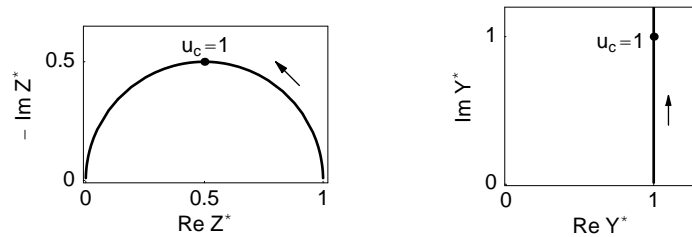

Figure 1.4: Nyquist diagram of the reduced impedance and admittance ( $Y^* = RY$ ) for the (R/C) circuit (Fig. 1.3, Eq. (1.2)).

## Chapter 2

# Circuits made of two Rs and one C

### 2.1 Circuit ( $R_2 + (R_1/C_1)$ )

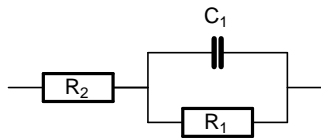

Figure 2.1: Circuit ( $R_2 + (R_1/C_1)$ ).

#### 2.1.1 Impedance

$$Z(\omega) = R_2 + \frac{1}{i\omega C_1 + \frac{1}{R_1}}$$

$$Z(\omega) = \frac{(R_1 + R_2)(1 + i\omega\tau_2)}{1 + i\omega\tau_1}, \quad \tau_1 = R_1 C_1, \quad \tau_2 = \frac{C_1 R_1 R_2}{R_1 + R_2}$$

#### 2.1.2 Reduced impedance

$$Z^*(u) = \frac{Z(u)}{R_1 + R_2} = \frac{1 + T i u}{1 + i u} \quad (2.1)$$

$$u = \tau_1 \omega, \quad T = \tau_2 / \tau_1 = R_2 / (R_1 + R_2) < 1$$

$$\operatorname{Re} Z^*(u) = \frac{1 + T u^2}{1 + u^2}, \quad \operatorname{Im} Z^*(u) = \frac{(T - 1) u}{1 + u^2}$$

$$\lim_{u \rightarrow 0} \operatorname{Re} Z^*(u) = 1, \quad \lim_{u \rightarrow \infty} \operatorname{Re} Z^*(u) = T$$

(Fig. 2.2)

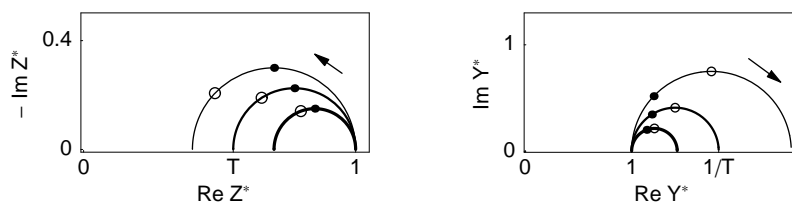

Figure 2.2: Nyquist diagram of the reduced impedance and admittance ( $Y^* = (R_1 + R_2)Y$ ) for the  $(R_2 + (R_1/C_1))$  circuit (Fig. 2.1, Eq. (2.1)) with  $T = 0.4, 0.55, 0.7$ . The line thickness increases with increasing  $T$ ). Dots: reduced characteristic angular frequency  $u_{c1} = 1$ ; circles: reduced characteristic angular frequency  $u_{c2} = 1/T$ .

## 2.2 Circuit $((R_1 + C_1)/R_2)$

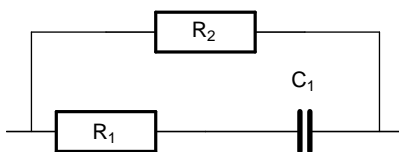

Figure 2.3: Circuit  $((R_1 + C_1)/R_2)$ .

### 2.2.1 Impedance

$$Z(\omega) = \frac{R_2 (1 + i\omega \tau_2)}{1 + i\omega \tau_1}, \quad \tau_1 = C_1 (R_1 + R_2), \quad \tau_2 = R_1 C_1$$

$$\operatorname{Re} Z(\omega) = \frac{R_2 (1 + \omega^2 \tau_1 \tau_2)}{1 + \omega^2 \tau_1^2}, \quad \operatorname{Im} Z(\omega) = \frac{\omega R_2 (-\tau_1 + \tau_2)}{1 + \omega^2 \tau_1^2}$$

### 2.2.2 Reduced impedance

$$Z^*(u) = Z(u)/R_2 = \frac{1 + T i u}{1 + i u} \quad (2.2)$$

$$u = \tau_1 \omega, \quad T = \tau_2/\tau_1 = R_1/(R_1 + R_2) < 1$$

cf. Eq. (2.1) and Fig. 2.2.

## 2.3 Transformation formulae between $(R + (R/C))$ and $((R + C)/R)$ circuits

### 2.3.1 Transformation formulae $(R + (R/C)) \rightarrow ((R + C)/R)$

$$R_{22} = R_{11} + R_{21}, \quad R_{12} = R_{21} + \frac{R_{21}^2}{R_{11}}, \quad C_{12} = \frac{C_{11} R_{11}^2}{(R_{11} + R_{21})^2}$$



2.3. TRANSFORMATION FORMULAE BETWEEN  $(R+(R/C))$  AND  $((R+C)/R)$  CIRCUITS 9

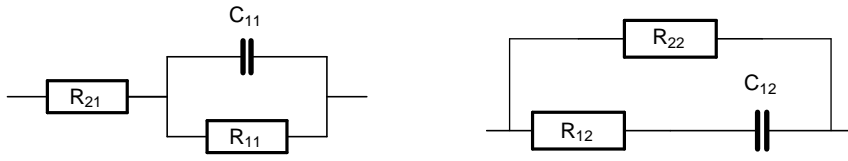

Figure 2.4: The  $(R+(R/C))$  and  $((R+C)/R)$  circuits are non-distinguishable [3, 2, 1, 6].

2.3.2 Transformation formulae  $((R+C)/R) \rightarrow (R+(R/C))$

$$C_{11} = \frac{C_{12} (R_{12} + R_{22})^2}{R_{22}^2}, R_{21} = \frac{R_{12} R_{22}}{R_{12} + R_{22}}, R_{11} = \frac{R_{22}^2}{R_{12} + R_{22}}$$



## Chapter 3

# Circuits made of one R and two Cs

### 3.1 Circuit $((R_1/C_1)+C_2)$

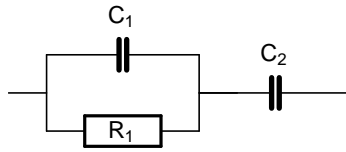

Figure 3.1: Circuit  $((R_1/C_1)+C_2)$ .

#### 3.1.1 Impedance

$$Z(\omega) = \frac{1}{i\omega C_1 + \frac{1}{R_1}} + \frac{1}{i\omega C_2} = \frac{1 + i\omega (C_1 + C_2) R_1}{i\omega C_2 (1 + i\omega C_1 R_1)}$$

$$Z(\omega) = \frac{1 + i\omega \tau_2}{i\omega C_2 (1 + i\omega \tau_1)}, \quad \tau_1 = R_1 C_1, \quad \tau_2 = (C_1 + C_2) R_1, \quad \tau_1 < \tau_2$$

$$\operatorname{Re} Z(\omega) = -\frac{\tau_1 - \tau_2}{C_2 (1 + \omega^2 \tau_1^2)}, \quad \operatorname{Im} Z(\omega) = -\frac{1 + \omega^2 \tau_1 \tau_2}{\omega C_2 (1 + \omega^2 \tau_1^2)}$$

$$\lim_{\omega \rightarrow 0} \operatorname{Re} Z(\omega) = R_1$$

#### 3.1.2 Reduced impedance

$$Z^*(u) = \frac{Z(u)}{R_1} = \frac{1}{T - 1} \frac{1 + T i u}{i u (1 + i u)} \quad (3.1)$$

$$u = \omega \tau_1, \quad T = \tau_2/\tau_1 = 1 + C_2/C_1 > 1$$

$$\operatorname{Re} Z^*(u) = \frac{1}{1+u^2}, \quad \operatorname{Im} Z^*(u) = -\frac{1+u^2 T}{(T-1)u(1+u^2)}$$

$$\lim_{u \rightarrow 0} \operatorname{Re} Z^*(u) = 1$$

(Fig. 3.2)

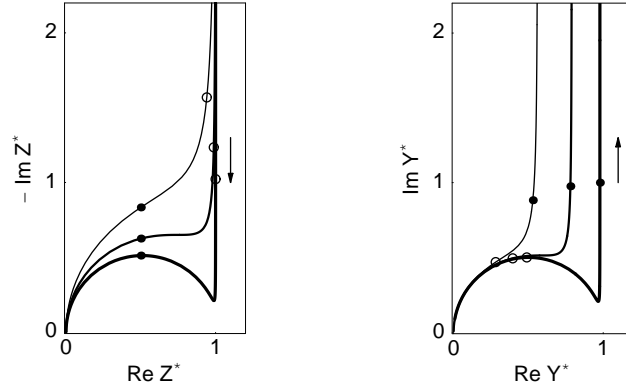
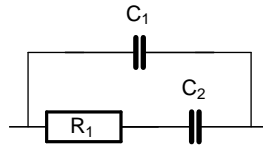

Figure 3.2: Nyquist diagram of the reduced impedance and admittance ( $Y^* = R_1 Y$ ) for the  $((R_1/C_1)+C_2)$  circuit (Fig. 3.1, Eq. (3.1)) plotted for  $T = 4, 9, 90$ . The line thickness increases with increasing  $T$ . Horizontal tangent is observed for  $T \geq 9$  ( $C_2/C_1 \geq 8$ ) [4]. Dots: reduced characteristic angular frequency  $u_{c1} = 1$ ; circles: reduced characteristic angular frequency  $u_{c2} = 1/T$ .

## 3.2 Circuit $((R_1+C_2)/C_1)$

Figure 3.3: Circuit  $((R_1+C_2)/C_1)$ .

### 3.2.1 Impedance

$$Z(\omega) = \frac{1}{i\omega C_1 + \frac{1}{R_1 + \frac{1}{i\omega C_2}}} = \frac{1 + i\omega C_2 R_1}{i\omega (C_1 + C_2) \left(1 + \frac{i\omega C_1 C_2 R_1}{C_1 + C_2}\right)}$$

$$Z(\omega) = \frac{(1 + i\omega \tau_2)}{i\omega (C_1 + C_2) (1 + i\omega \tau_1)}, \quad \tau_1 = \frac{C_1 C_2 R_1}{C_1 + C_2}, \quad \tau_2 = C_2 R_1 \quad (3.2)$$

### 3.3. TRANSFORMATION FORMULAE BETWEEN ((R/C)/C) AND ((R+C)/C) CIRCUITS 13

$$\operatorname{Re} Z(\omega) = \frac{-\tau_1 + \tau_2}{(C_1 + C_2)(1 + \omega^2 \tau_1^2)}, \quad \operatorname{Im} Z(\omega) = -\frac{1 + \omega^2 \tau_1 \tau_2}{\omega (C_1 + C_2)(1 + \omega^2 \tau_1^2)}$$

$$\lim_{\omega \rightarrow 0} \operatorname{Re} Z(\omega) = \frac{C_2^2 R_1}{(C_1 + C_2)^2}$$

#### 3.2.2 Reduced impedance

$$Z^*(u) = \frac{Z(u)}{R_1} = \frac{T-1}{T^2} \frac{1+Tiu}{iu(1+iu)} \quad (3.3)$$

$$u = \omega \tau_1, \quad T = \tau_2/\tau_1 = 1 + C_2/C_1 > 1$$

$$\operatorname{Re} Z^*(u) = \frac{(-1+T)^2}{T^2(1+u^2)}, \quad \operatorname{Im} Z^*(u) = -\frac{(-1+T)(1+Tu^2)}{T^2 u(1+u^2)}$$

$$\lim_{u \rightarrow 0} \operatorname{Re} Z^*(u) = \frac{(-1+T)^2}{T^2} = \frac{C_2^2}{(C_1 + C_2)^2}$$

(Fig. 3.4)

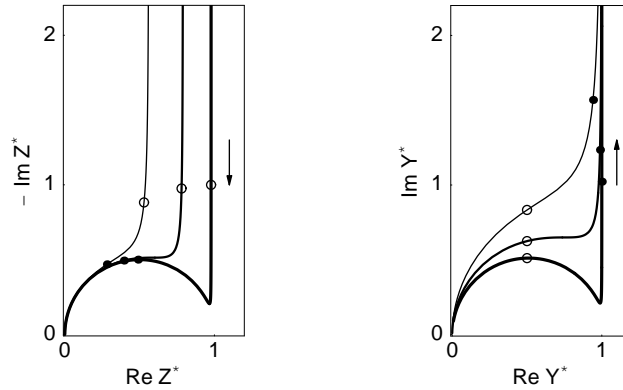

Figure 3.4: Nyquist diagram of the reduced impedance and admittance ( $Y^* = R_1 Y$ ) for the  $((R_1+C_2)/C_1)$  circuit (Fig. 3.3, Eq. (3.3)) plotted for  $T = 4, 9, 90$ . The line thickness increases with increasing  $T$ . Horizontal tangent is observed for  $T \geq 9$ . ( $C_2/C_1 \geq 8$ ). Dots: reduced characteristic angular frequency  $u_{c1} = 1$ ; circles: reduced characteristic angular frequency:  $u_{c2} = 1/T$ .

### 3.3 Transformation formulae between ((R/C)/C) and ((R+C)/C) circuits

#### 3.3.1 Transformation formulae $((R/C)/C) \rightarrow ((R+C)/C)$

$$C_{22} = \frac{C_{11} C_{21}}{C_{11} + C_{21}}, \quad R_{12} = \frac{(C_{11} + C_{21})^2 R_{11}}{C_{21}^2}, \quad C_{12} = \frac{C_{21}^2}{C_{11} + C_{21}}$$

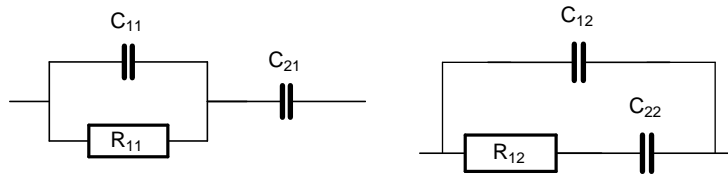

Figure 3.5: The  $((R/C)/C)$  and  $((R+C)/C)$  circuits are non-distinguishable [3, 2, 1, 6].

### 3.3.2 Transformation formulae $((R+C)/C) \rightarrow ((R/C)/C)$

$$C_{11} = C_{22} + \frac{C_{22}^2}{C_{12}}, R_{11} = \frac{C_{12}^2 R_{12}}{(C_{12} + C_{22})^2}, C_{21} = C_{12} + C_{22}$$

## Chapter 4

# Circuits made of two Rs and two Cs

### 4.1 Circuit $((R_1/C_1)+(R_2/C_2))$

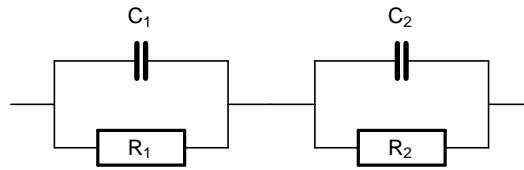

Figure 4.1: Circuit  $((R_1/C_1)+(R_2/C_2))$ .

#### 4.1.1 Impedance

$$Z(\omega) = \frac{1}{i\omega C_1 + \frac{1}{R_1}} + \frac{1}{i\omega C_2 + \frac{1}{R_2}} = \frac{(R_1 + R_2)(1 + i\omega\tau_3)}{(1 + i\omega\tau_1)(1 + i\omega\tau_2)}$$

$$\tau_1 = R_1 C_1, \tau_2 = R_2 C_2, \tau_3 = \frac{(C_1 + C_2) R_1 R_2}{R_1 + R_2} = \frac{\tau_1 R_2 + \tau_2 R_1}{R_1 + R_2}$$

$$\operatorname{Re} Z(\omega) = \frac{(R_1 + R_2)(1 + \omega^2(-\tau_1\tau_2 + (\tau_1 + \tau_2)\tau_3))}{(1 + \omega^2\tau_1^2)(1 + \omega^2\tau_2^2)}$$

$$\operatorname{Im} Z(\omega) = -\frac{\omega(R_1 + R_2)(\tau_1 + \tau_2 + (-1 + \omega^2\tau_1\tau_2)\tau_3)}{(1 + \omega^2\tau_1^2)(1 + \omega^2\tau_2^2)}$$

#### 4.1.2 Reduced impedance

$$Z^*(u) = \frac{Z(u)}{R_1 + R_2} = \frac{1 + \rho + (T + \rho)iu}{(1 + \rho)(1 + iu)(1 + iT)}$$

$$u = R_2 C_2 \omega, \rho = R_1/R_2, T = R_1 C_1/(R_2 C_2) = \gamma\rho, \gamma = C_1/C_2$$

(Figs. 4.2-4.5)

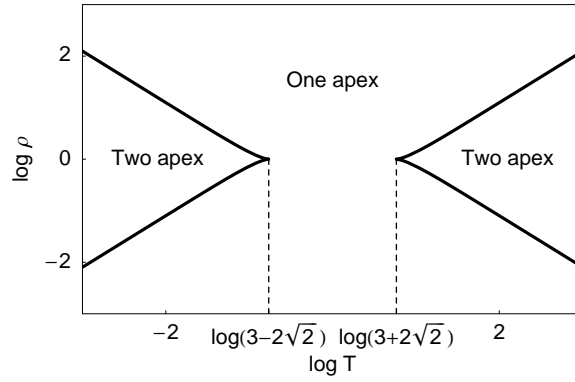

Figure 4.2: Case diagram for the  $((R_1/C_1)+(R_2/C_2))$  circuit plotted using the  $\log \rho$  vs.  $\log T$  representation.

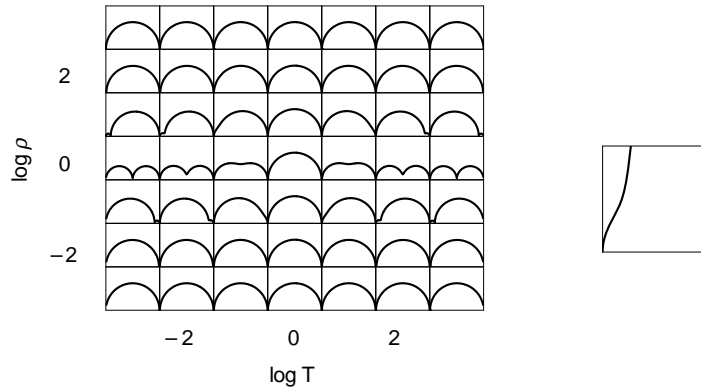

Figure 4.3: Array of impedance diagrams plotted for the  $((R_1/C_1)+(R_2/C_2))$  circuit, depending on  $\rho$  and  $T$  values, and enlargement of the high frequency part of the diagram calculated for  $T = 10^{-2}$  and  $\rho = 10^{-2}$ .

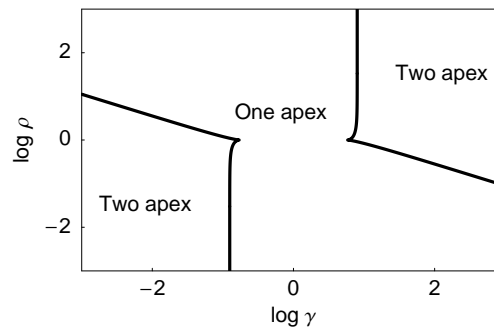

Figure 4.4: Case diagram for the  $((R_1/C_1)+(R_2/C_2))$  circuit, using the  $\log \rho$  vs.  $\log \gamma$  representation.



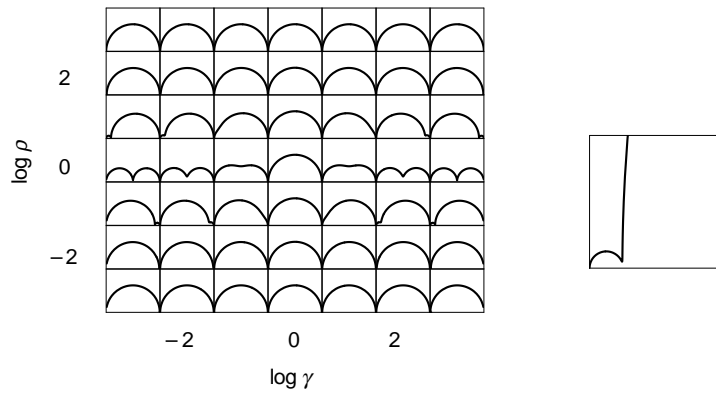
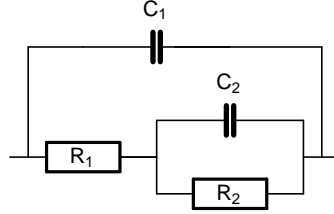

Figure 4.5: Array of impedance diagrams plotted for the  $((R_1/C_1)+(R_2/C_2))$  circuit, depending on  $\rho$  and  $\gamma$  values and enlargement of the high frequency part of the diagram calculated for  $\gamma = 10^{-2}$  and  $\rho = 10^{-2}$ .

## 4.2 Circuit $((R_1 + (R_2/C_2))/C_1)$

Figure 4.6: Circuit  $((R_1 + (R_2/C_2))/C_1)$ .

### 4.2.1 Impedance

$$Z(\omega) = \frac{1}{i\omega C_1 + \frac{1}{R_1 + \frac{R_2}{1 + i\omega C_2 R_2}}}$$

$$Z(\omega) = \frac{(R_1 + R_2) \left(1 + \frac{i\omega C_2 R_1 R_2}{R_1 + R_2}\right)}{1 + i\omega (C_2 R_2 + C_1 (R_1 + R_2)) + (i\omega)^2 C_1 C_2 R_1 R_2}$$

$$Z(\omega) = \frac{(R_1 + R_2) (1 + i\omega \tau_3)}{(1 + i\omega \tau_1) (1 + i\omega \tau_2)}, \quad \tau_3 = \frac{C_2 R_1 R_2}{R_1 + R_2}$$

The poles of the impedance of a circuit made of Rs and Cs are always real [5].

$$\tau_1 = \frac{C_2 R_2 + C_1 (R_1 + R_2) - \sqrt{-4 C_1 C_2 R_1 R_2 + (C_2 R_2 + C_1 (R_1 + R_2))^2}}{2} \quad (4.1)$$

$$\tau_2 = \frac{C_2 R_2 + C_1 (R_1 + R_2) + \sqrt{-4 C_1 C_2 R_1 R_2 + (C_2 R_2 + C_1 (R_1 + R_2))^2}}{2} \quad (4.2)$$

### 4.2.2 Reduced impedance

$$Z^*(u) = \frac{Z(u)}{R_1 + R_2} = \frac{\rho}{1 + \rho} \frac{1 + \rho(1 + iu)}{iuT + \rho(1 + iu)(1 + iuT)}$$

$$u = R_2 C_2 \omega, \quad \rho = R_1/R_2, \quad T = R_1 C_1/(R_2 C_2) = \gamma \rho, \quad \gamma = C_1/C_2$$

(Figs. 4.7-4.10)

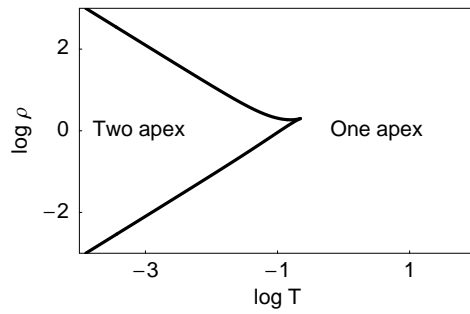

Figure 4.7: Case diagram for the  $((R_1+(R_2/C_2))/C_1)$  circuit plotted using the  $\log \rho$  vs.  $\log T$  representation.

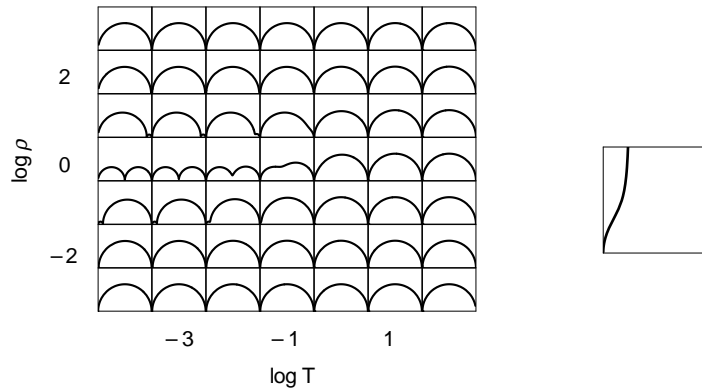

Figure 4.8: Array of impedance diagrams plotted for the  $((R_1+(R_2/C_2))/C_1)$  circuit, depending on  $\rho$  and  $T$  values, and enlargement of the high frequency part of the diagram calculated for  $T = 10^{-3}$  and  $\rho = 10^{-3}$ .

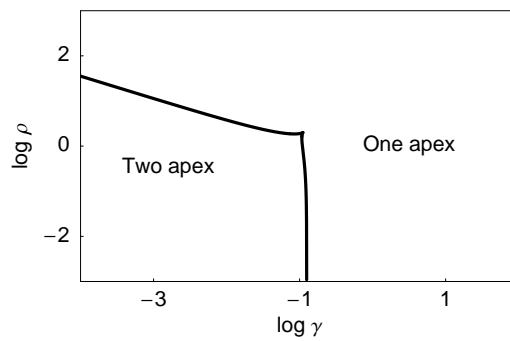

Figure 4.9: Case diagram for the  $((R_1+(R_2/C_2))/C_1)$  circuit plotted using the  $\log \rho$  vs.  $\log \gamma$  representation.

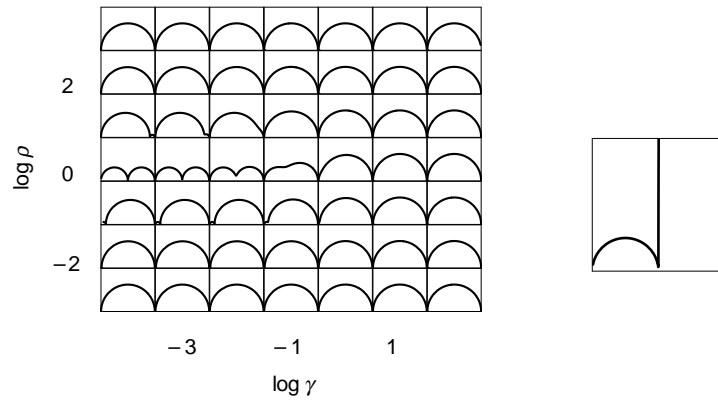
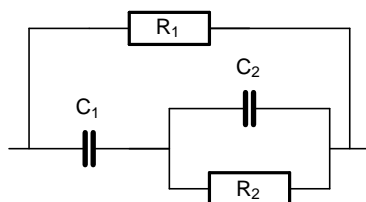

Figure 4.10: Array of impedance diagrams plotted for the  $((R_1 + (R_2/C_2))/C_1)$  circuit, depending on  $\rho$  and  $\gamma$  values, and enlargement of the high frequency part of the diagram calculated for  $\gamma = 10^{-3}$  and  $\rho = 10^{-3}$ .

### 4.3 Circuit $((C_1 + (R_2/C_2))/R_1)$

Figure 4.11: Circuit  $((C_1 + (R_2/C_2))/R_1)$ .

#### 4.3.1 Impedance

$$Z(\omega) = \frac{1}{\frac{1}{R_1} + \frac{1}{\frac{1}{i\omega C_1} + \frac{R_2}{1 + i\omega C_2 R_2}}}$$

$$Z(\omega) = \frac{R_1 (1 + i\omega (C_1 + C_2) R_2)}{1 + i\omega (C_2 R_2 + C_1 (R_1 + R_2)) + (i\omega)^2 C_1 C_2 R_1 R_2}$$

$$Z(\omega) = \frac{R_1 (1 + i\omega \tau_3)}{(1 + i\omega \tau_1) (1 + i\omega \tau_2)}, \quad \tau_3 = (C_1 + C_2) R_2, \quad \tau_1 : \text{Éq. (4.1)}, \quad \tau_2 : \text{Éq. (4.2)}$$

#### 4.3.2 Reduced impedance

$$Z^*(u) = Z(u)/R_1 = \frac{\rho + iu (\rho + T)}{iuT + \rho (1 + iu) (1 + iuT)}$$

$$u = R_2 C_2 \omega, \quad \rho = R_1/R_2, \quad T = R_1 C_1 / (R_2 C_2) = \gamma \rho, \quad \gamma = C_1/C_2$$

(Figs. 4.12 and 4.13)

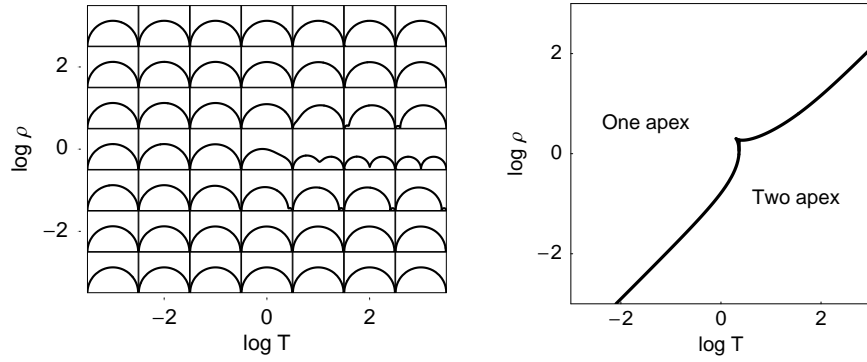

Figure 4.12: Impedance diagrams array and case diagram for the  $((C_1+(R_2/C_2))/R_1)$  circuit using the  $\log \rho$  vs.  $\log T$  representation.

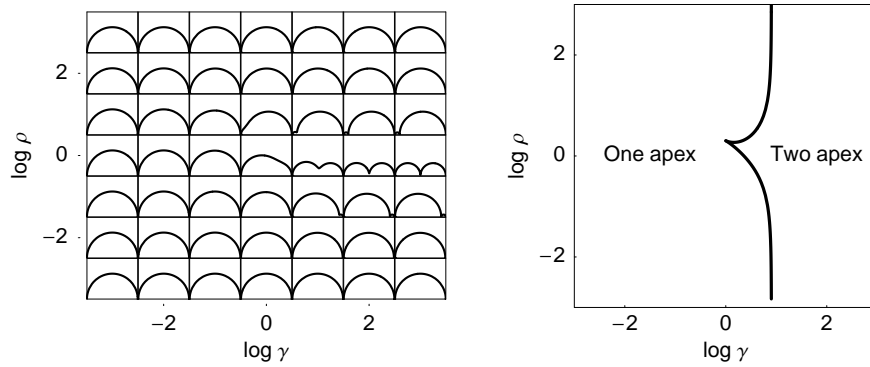
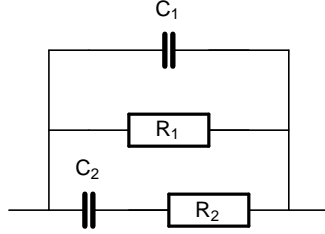

Figure 4.13: Impedance diagrams array and case diagram for the  $((C_1+(R_2/C_2))/R_1)$  circuit using the  $\log \rho$  vs.  $\log \gamma$  representation.

#### 4.4 Circuit $((C_2+R_2)/R_1)/C_1$

Figure 4.14: Circuit  $((C_2+R_2)/R_1)/C_1$ .

##### 4.4.1 Impedance

$$Z(\omega) = \frac{1}{i\omega C_1 + \frac{1}{R_1} + \frac{1}{\frac{1}{i\omega C_2} + R_2}}$$

$$Z(\omega) = \frac{R_1 (1 + i\omega C_2 R_2)}{1 + i\omega (C_1 R_1 + C_2 (R_1 + R_2)) + (i\omega)^2 C_1 C_2 R_1 R_2}$$

$$Z(\omega) = \frac{R_1 (1 + i\omega \tau_3)}{(1 + i\omega \tau_1) (1 + i\omega \tau_2)}$$

$\tau_3 = R_2 C_2$ ;  $\tau_1$ : Eq. (4.1),  $\tau_2$ : Eq. (4.2) (exchanging subscripts 1 and 2)

##### 4.4.2 Reduced impedance

$$Z^*(u) = Z(u)/R_1 = \frac{1 + iu}{1 + iu (1 + \rho + \tau (1 + iu))}$$

$$u = R_2 C_2 \omega, \rho = R_1/R_2, T = R_1 C_1/(R_2 C_2) = \gamma \rho, \gamma = C_1/C_2$$

(Figs. 4.15 and 4.16)

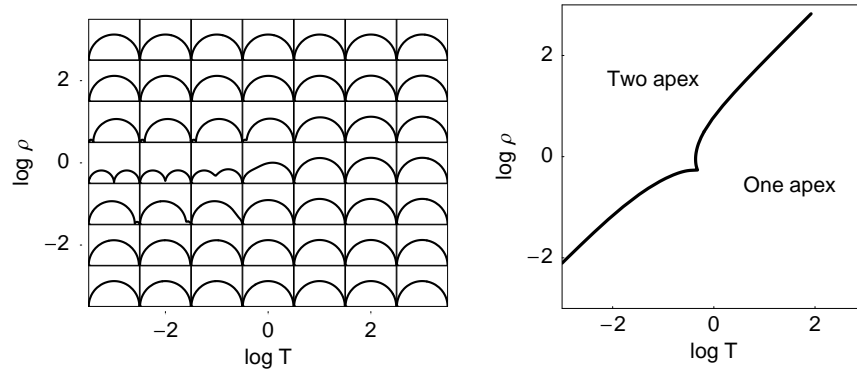

Figure 4.15: Impedance diagrams array and case diagram for the  $\left(\frac{C_2+R_2}{R_1}\right)/C_1$  circuit using the  $\log \rho$  vs.  $\log T$  representation.

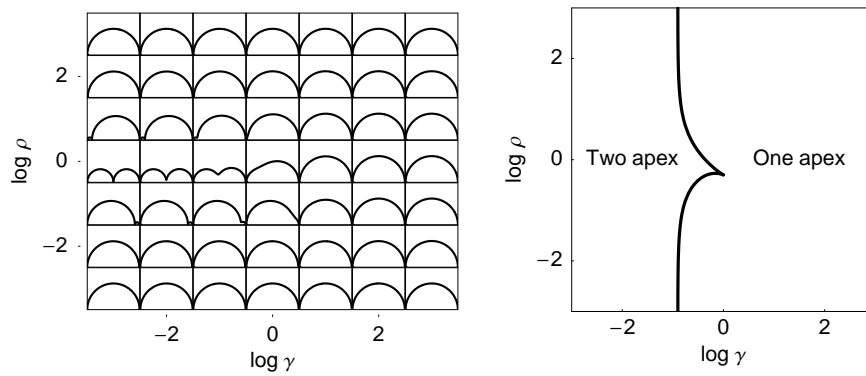

Figure 4.16: Impedance diagrams array and case diagram for the  $\left(\frac{C_2+R_2}{R_1}\right)/C_1$  circuit using the  $\log \rho$  vs.  $\log \gamma$  representation.



## 4.5 Transformation formulae for the four circuits made of two Rs and two Cs

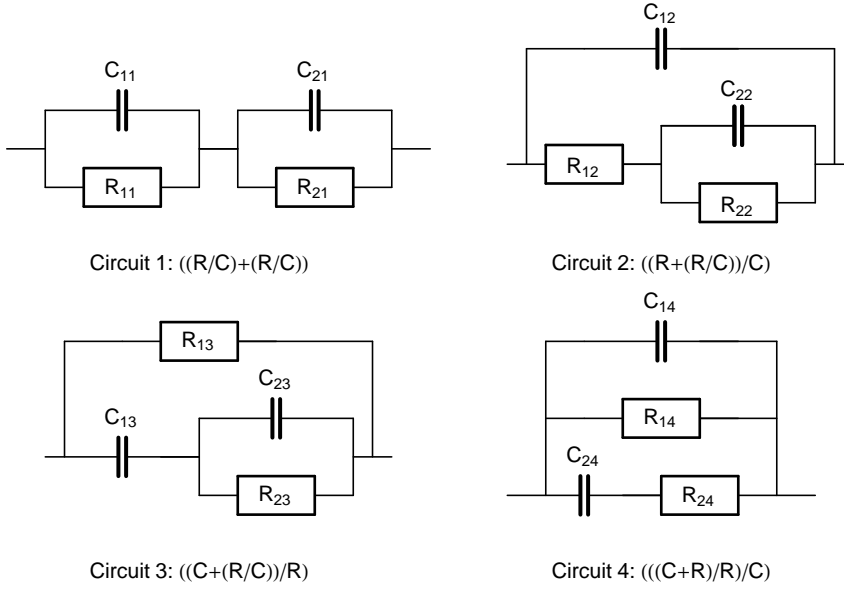

Figure 4.17: The four circuits are non-distinguishable [3, 2, 1, 6].

The four circuits are non-distinguishable [3, 2, 1, 6]. 12 transformation formulae exist between the four circuits.

### 4.5.1 Transformation formulae circuit 2 $\rightarrow$ circuit 1

$$C_{11} = \frac{1}{2 C_{22} R_{22}^2} \sqrt{C_{22}^2 R_{22}^2 + 2 C_{12} C_{22} R_{22} (-R_{12} + R_{22}) + C_{12}^2 (R_{12} + R_{22})^2} \\ \times (C_{22} R_{22} - C_{12} (R_{12} + R_{22}) + \sqrt{C_{22}^2 R_{22}^2 + 2 C_{12} C_{22} R_{22} (-R_{12} + R_{22}) + C_{12}^2 (R_{12} + R_{22})^2})$$

$$C_{21} = \frac{1}{2 C_{22} R_{22}^2} \sqrt{C_{22}^2 R_{22}^2 + 2 C_{12} C_{22} R_{22} (-R_{12} + R_{22}) + C_{12}^2 (R_{12} + R_{22})^2} \\ \times (-C_{22} R_{22} + C_{12} (R_{12} + R_{22}) + \sqrt{C_{22}^2 R_{22}^2 + 2 C_{12} C_{22} R_{22} (-R_{12} + R_{22}) + C_{12}^2 (R_{12} + R_{22})^2})$$

$$R_{21} = \left( C_{22} (R_{12} - R_{22}) R_{22} - C_{12} (R_{12} + R_{22})^2 + \right. \\ \left. (R_{12} + R_{22}) \sqrt{C_{22}^2 R_{22}^2 + 2 C_{12} C_{22} R_{22} (-R_{12} + R_{22}) + C_{12}^2 (R_{12} + R_{22})^2} \right) / \\ \left( 2 \sqrt{C_{22}^2 R_{22}^2 + 2 C_{12} C_{22} R_{22} (-R_{12} + R_{22}) + C_{12}^2 (R_{12} + R_{22})^2} \right)$$

$$R_{11} = \frac{1}{2} \left( R_{12} + R_{22} + \frac{C_{22} R_{22} (-R_{12} + R_{22}) + C_{12} (R_{12} + R_{22})^2}{\sqrt{C_{22}^2 R_{22}^2 + 2 C_{12} C_{22} R_{22} (-R_{12} + R_{22}) + C_{12}^2 (R_{12} + R_{22})^2}} \right)$$

#### 4.5.2 Transformation formulae circuit 1 $\rightarrow$ circuit 2

$$C_{12} = \frac{C_{11} C_{21}}{C_{11} + C_{21}}, C_{22} = \frac{(C_{11}^2 R_{11} + C_{21}^2 R_{21})^2}{(C_{11} + C_{21}) (C_{11} R_{11} - C_{21} R_{21})^2}$$

$$R_{12} = \frac{(C_{11} + C_{21})^2 R_{11} R_{21}}{C_{11}^2 R_{11} + C_{21}^2 R_{21}}, R_{22} = \frac{(C_{11} R_{11} - C_{21} R_{21})^2}{C_{11}^2 R_{11} + C_{21}^2 R_{21}}$$

#### 4.5.3 Transformation formulae circuit 3 $\rightarrow$ circuit 1

$$C_{11} = \frac{1}{2 C_{13}^2 R_{13}^2} (C_{13}^2 (C_{13} + C_{23}) R_{13}^2 + 2 C_{13} (C_{13}^2 - C_{23}^2) R_{13} R_{23} + \\ (C_{13} + C_{23})^3 R_{23}^2 - (C_{13} (C_{13} - C_{23}) R_{13} + (C_{13} + C_{23})^2 R_{23}) \\ \times \sqrt{C_{23}^2 R_{23}^2 + 2 C_{13} C_{23} R_{23} (-R_{13} + R_{23}) + C_{13}^2 (R_{13} + R_{23})^2})$$

$$C_{21} = \frac{1}{2 C_{13}^2 R_{13}^2} (C_{13}^2 (C_{13} + C_{23}) R_{13}^2 + 2 C_{13} (C_{13}^2 - C_{23}^2) R_{13} R_{23} + \\ (C_{13} + C_{23})^3 R_{23}^2 + (C_{13} (C_{13} - C_{23}) R_{13} + (C_{13} + C_{23})^2 R_{23}) \\ \times \sqrt{C_{23}^2 R_{23}^2 + 2 C_{13} C_{23} R_{23} (-R_{13} + R_{23}) + C_{13}^2 (R_{13} + R_{23})^2})$$

$$R_{21} = R_{13} (C_{13} R_{13} - (C_{13} + C_{23}) R_{23} + \\ \sqrt{C_{23}^2 R_{23}^2 + 2 C_{13} C_{23} R_{23} (-R_{13} + R_{23}) + C_{13}^2 (R_{13} + R_{23})^2}) / \\ \left( 2 \sqrt{C_{23}^2 R_{23}^2 + 2 C_{13} C_{23} R_{23} (-R_{13} + R_{23}) + C_{13}^2 (R_{13} + R_{23})^2} \right)$$

$$R_{11} = \frac{R_{13}}{2} \left( 1 + \frac{-C_{13} R_{13} + (C_{13} + C_{23}) R_{23}}{\sqrt{C_{23}^2 R_{23}^2 + 2 C_{13} C_{23} R_{23} (-R_{13} + R_{23}) + C_{13}^2 (R_{13} + R_{23})^2}} \right)$$

**4.5.4 Transformation formulae circuit 1 → circuit 3**

$$R_{13} = R_{11} + R_{21}, C_{23} = \frac{C_{11} C_{21} (C_{11} R_{11}^2 + C_{21} R_{21}^2)}{(C_{11} R_{11} - C_{21} R_{21})^2}$$

$$C_{13} = \frac{C_{11} R_{11}^2 + C_{21} R_{21}^2}{(R_{11} + R_{21})^2}, R_{23} = \frac{R_{11} R_{21} (R_{11} + R_{21}) (C_{11} R_{11} - C_{21} R_{21})^2}{(C_{11} R_{11}^2 + C_{21} R_{21}^2)^2}$$

**4.5.5 Transformation formulae circuit 4 → circuit 1**

$$C_{11} = \frac{1}{2 C_{24} R_{14}^2} \sqrt{C_{14}^2 R_{14}^2 + 2 C_{14} C_{24} R_{14} (R_{14} - R_{24}) + C_{24}^2 (R_{14} + R_{24})^2}$$

$$\times (C_{14} R_{14} - C_{24} (R_{14} + R_{24}) + \sqrt{C_{14}^2 R_{14}^2 + 2 C_{14} C_{24} R_{14} (R_{14} - R_{24}) + C_{24}^2 (R_{14} + R_{24})^2})$$

$$C_{21} = \frac{1}{2 C_{24} R_{14}^2} \sqrt{C_{14}^2 R_{14}^2 + 2 C_{14} C_{24} R_{14} (R_{14} - R_{24}) + C_{24}^2 (R_{14} + R_{24})^2}$$

$$\times (-C_{14} R_{14} + C_{24} (R_{14} + R_{24}) + \sqrt{C_{14}^2 R_{14}^2 + 2 C_{14} C_{24} R_{14} (R_{14} - R_{24}) + C_{24}^2 (R_{14} + R_{24})^2})$$

$$R_{21} = (R_{14} ((C_{14} + C_{24}) R_{14} - C_{24} R_{24} + \sqrt{C_{14}^2 R_{14}^2 + 2 C_{14} C_{24} R_{14} (R_{14} - R_{24}) + C_{24}^2 (R_{14} + R_{24})^2})) /$$

$$\left( 2 \sqrt{C_{14}^2 R_{14}^2 + 2 C_{14} C_{24} R_{14} (R_{14} - R_{24}) + C_{24}^2 (R_{14} + R_{24})^2} \right)$$

$$R_{11} = \frac{R_{14}}{2} \left( 1 + \frac{-(C_{14} + C_{24}) R_{14} + C_{24} R_{24}}{\sqrt{C_{14}^2 R_{14}^2 + 2 C_{14} C_{24} R_{14} (R_{14} - R_{24}) + C_{24}^2 (R_{14} + R_{24})^2}} \right)$$

**4.5.6 Transformation formulae circuit 1 → circuit 4**

$$C_{14} = \frac{C_{11} C_{21}}{C_{11} + C_{21}}, R_{14} = R_{11} + R_{21}$$

$$R_{24} = \frac{(C_{11} + C_{21})^2 R_{11} R_{21} (R_{11} + R_{21})}{(C_{11} R_{11} - C_{21} R_{21})^2}, C_{24} = \frac{(C_{11} R_{11} - C_{21} R_{21})^2}{(C_{11} + C_{21}) (R_{11} + R_{21})^2}$$

**4.5.7 Transformation formulae circuit 3 → circuit 2**

$$C_{12} = \frac{C_{13} C_{23}}{C_{13} + C_{23}}, C_{22} = \frac{(C_{13}^2 R_{13} + (C_{13} + C_{23})^2 R_{23})^2}{C_{13}^2 (C_{13} + C_{23}) R_{13}^2}$$

$$R_{12} = \frac{(C_{13} + C_{23})^2 R_{13} R_{23}}{C_{13}^2 R_{13} + (C_{13} + C_{23})^2 R_{23}}, R_{22} = \frac{C_{13}^2 R_{13}^2}{C_{13}^2 R_{13} + (C_{13} + C_{23})^2 R_{23}}$$

**4.5.8 Transformation formulae circuit 2  $\rightarrow$  circuit 3**

$$R_{13} = R_{12} + R_{22}, C_{23} = \frac{C_{12} \left( C_{22} R_{22}^2 + C_{12} (R_{12} + R_{22})^2 \right)}{C_{22} R_{22}^2}$$

$$C_{13} = C_{12} + \frac{C_{22} R_{22}^2}{(R_{12} + R_{22})^2}, R_{23} = \frac{C_{22}^2 R_{12} R_{22}^3 (R_{12} + R_{22})}{\left( C_{22} R_{22}^2 + C_{12} (R_{12} + R_{22})^2 \right)^2}$$

**4.5.9 Transformation formulae circuit 4  $\rightarrow$  circuit 2**

$$C_{12} = C_{14}, C_{22} = \frac{C_{24} (R_{14} + R_{24})^2}{R_{14}^2}, R_{12} = \frac{R_{14} R_{24}}{R_{14} + R_{24}}, R_{22} = \frac{R_{14}^2}{R_{14} + R_{24}}$$

**4.5.10 Transformation formulae circuit 2  $\rightarrow$  circuit 4**

$$C_{14} = C_{12}, R_{14} = R_{12} + R_{22}, R_{24} = R_{12} + \frac{R_{12}^2}{R_{22}}, C_{24} = \frac{C_{22} R_{22}^2}{(R_{12} + R_{22})^2}$$

**4.5.11 Transformation formulae circuit 4  $\rightarrow$  circuit 3**

$$R_{13} = R_{14}, C_{23} = C_{14} + \frac{C_{14}^2}{C_{24}}, C_{13} = C_{14} + C_{24}, R_{23} = \frac{C_{24}^2 R_{24}}{(C_{14} + C_{24})^2}$$

**4.5.12 Transformation formulae circuit 3  $\rightarrow$  circuit 4**

$$C_{14} = \frac{C_{13} C_{23}}{C_{13} + C_{23}}, R_{24} = \frac{(C_{13} + C_{23})^2 R_{23}}{C_{13}^2}, R_{14} = R_{13}, C_{24} = \frac{C_{13}^2}{C_{13} + C_{23}}$$

# Bibliography

- [1] FLETCHER, S. *J. Electrochem. Soc.* 141 (1994), 1823.
- [2] MACDONALD, J. R. *Impedance spectroscopy. Emphasizing solid materials and systems.* John Wiley & Sons, 1987.
- [3] NOVOSEL'SKII, I. M., GUDINA, N. N., AND FETISTOV, Y. I. *Élektrokhimiya* 8 (1972), 565.
- [4] SIBERT, E. *Electrosorption sur surface Pt(111), influence des anions.* PhD thesis, ENSEEG/INPG, Grenoble, Sept. 2000.
- [5] TEMES, G. C., AND LAPATRA, J. W. *Introduction to Circuits Synthesis and Design.* McGraw-Hill, New-York, 1977.
- [6] WALTER, E., AND PRONZATO, L. *Identification de modèles paramétriques à partir de données expérimentales.* Masson, Paris, 1994.